

Reverse Voltage 50V~1000V Output Current 15A

Features

- Thin Single In-Line package;
- Ideal for printed circuit boards;
- Glass Passivated chip junction;
- High Surge current capability;
- High case dielectric strength of 2500 VRMS;
- Plastic package has Underwrites Laboratory Flammability Classification 94V-0;

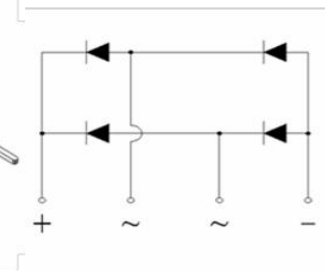
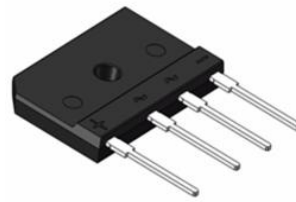

GBJ

Typical Applications

- General purpose use in AC-to-DC bridge full wave rectification for Switching Power Supply, Home Appliances, Office Equipment, Industrial Automation applications.

Mechanical Data

- Case: GBJ(5S)Molded plastic body;Base P/N with suffix"E" on packing code-halogen free
- Terminals:Plated leads solderable per MIL-STD-750,Method 2026;
- High temperature soldering guaranteed: Solder Dip 260°C,10seconds;
- Polarity: As marked on body;
- Mounting Torque: 10cm·kg (8.8 inches·lbs) max;
- Recommend Torque:Mounting Torque: 5.7cm·kg (5inches·lbs);

Maximum Ratings (TA = 25 °C unless otherwise noted)

Parameter	Symbol	GBJ15A	GBJ15B	GBJ15D	GBJ15G	GBJ15J	GBJ15K	GBJ15M	Unit
Maximum repetitive peak reverse voltage	V_{RRM}	50	100	200	400	600	800	1000	V
Maximum RMS voltage	V_{RMS}	35	70	140	280	420	560	700	V
Maximum DC blocking voltage	V_{DC}	50	100	200	400	600	800	1000	V
Maximum average forward rectified output current at	TA=107°C	15 ⁽¹⁾							A
	TA=25°C	3.5 ⁽²⁾							
Peak forward surge current 8.3 ms single half sine-wave superimposed on rated load	I_{FSM}	200							A
Rating for fusing(t<8.3ms)	I^2t	167							A ² sec
Operating junction and storage temperature range	T_J, T_{STG}	- 55 to + 150							°C

Electrical Characteristics (TA = 25 °C unless otherwise noted)

Parameter	Symbol	GBJ15A	GBJ15B	GBJ15D	GBJ15G	GBJ15J	GBJ15K	GBJ15M	Unit
Maximum instantaneous forward voltage drop per leg at 7.5A	V_F				1.00				Volts
Maximum DC reverse at rated DC blocking voltage per leg	TA=25°C				5.00				μA
	TA=125°C				250.00				

Thermal Characteristics

Parameter	Symbol	GBJ15A	GBJ15B	GBJ15D	GBJ15G	GBJ15J	GBJ15K	GBJ15M	Unit
Typical thermal resistance per leg	$R_{\theta JA}^{(2)}$				22 ⁽²⁾				° C /W
	$R_{\theta JC}^{(3)}$				1.5 ⁽¹⁾				

- 1). Unit case mounted on Al plate heatsink;
- 2). Units mounted on PCB without heatsink;
- 3). Recommended mounting position is to bolt down on heatsink with silicone thermal compound for maximum heat transfer with M3screw.

Ratings and Characteristics Curves

(TA = 25° C unless otherwise noted)

FIG.1-DERATING CURVE FOR OUTPUT RECTIFIED CURRENT

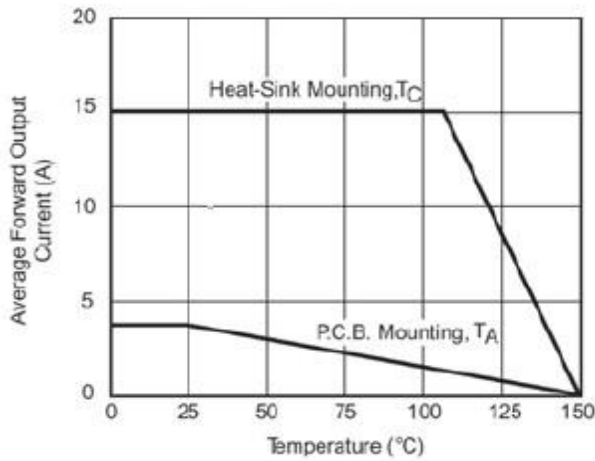

FIG.2-TYPICAL INSTANTANEOUS FORWARD CHARACTERISTICS

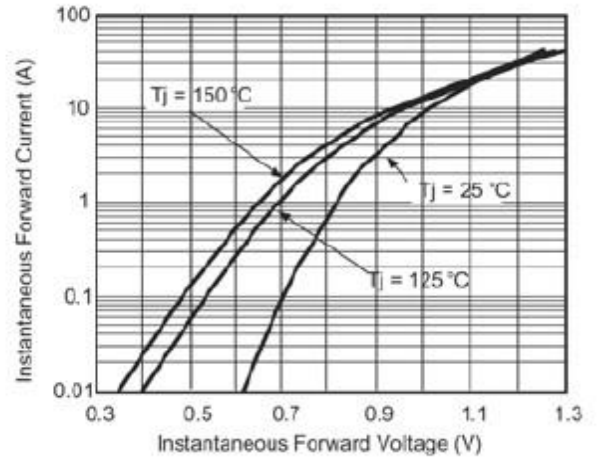

FIG.3-TYPICAL REAK REVERSE VOLTAGE CHARACTERISTICS

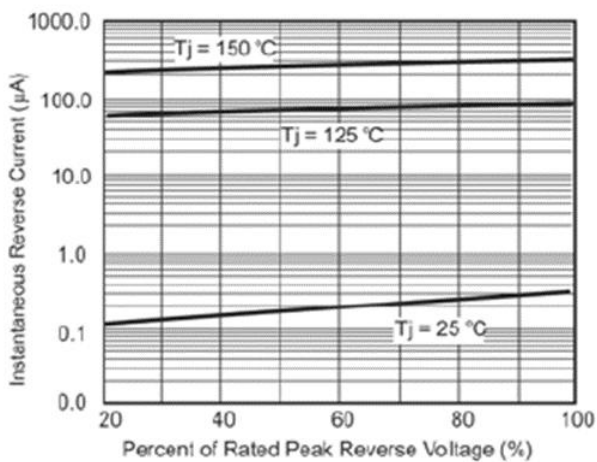
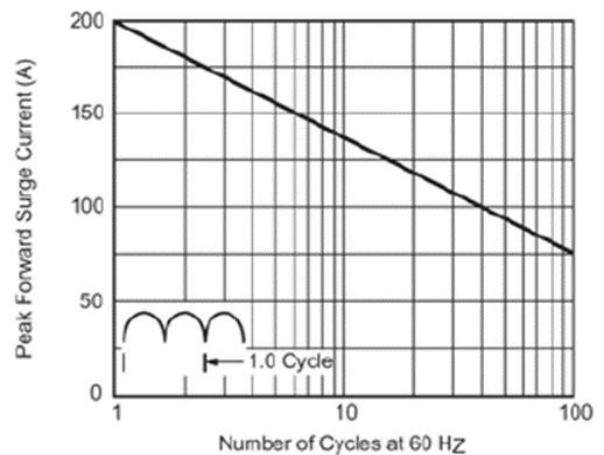

FIG.4-MAXIMUM NON-REPETITIVE PEAK FORWARD SURGE CURRENT



Package Outline Dimensions

in millimeters

First angle projection

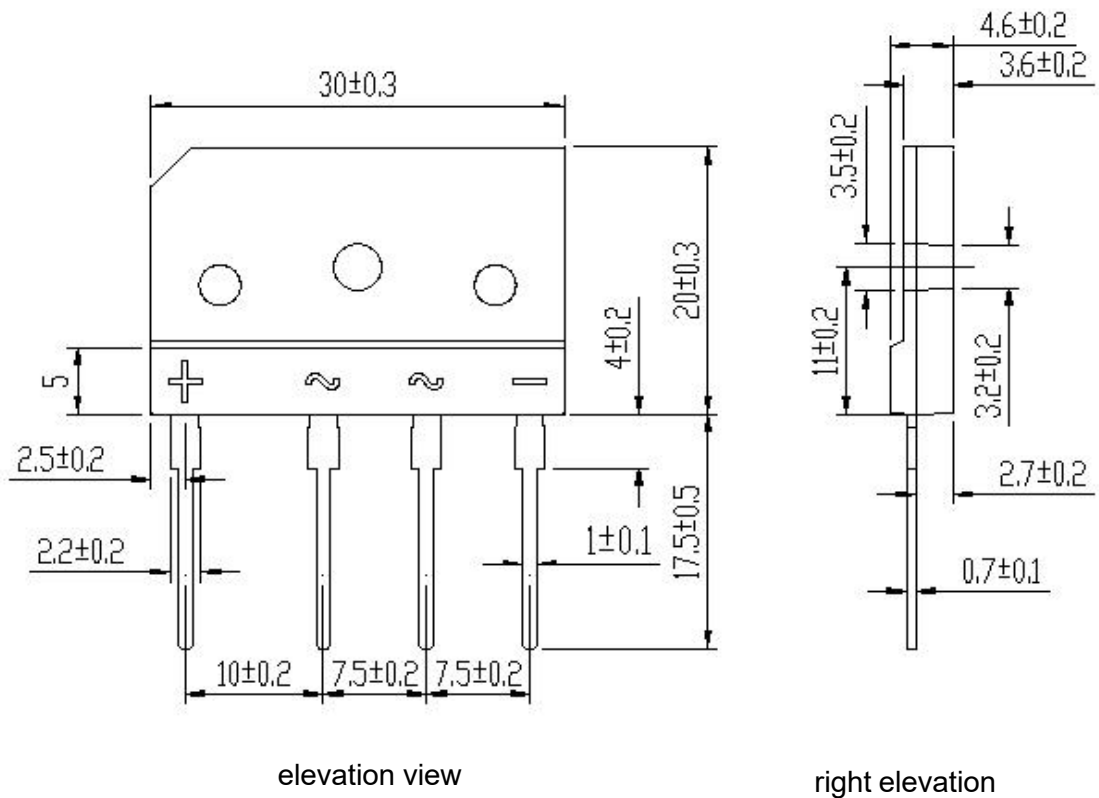

Revision History

Document Version	Date of release	Discription of changes
Rev.A	2021/3/1	Released Datasheet
Rev.B	2023/12/17	Modify document format

Disclaimers

These materials are intended as a reference to assist our customers in the selection of the Suzhou Good-Ark product best suited to the customer's application; they do not convey any license under any intellectual property rights, or any other rights, belonging to Suzhou Good-Ark Electronics Co., Ltd. or a third party.

Suzhou Good-Ark Electronics Co., Ltd. assumes no responsibility for any damage, or infringement of any third-party's rights, originating in the use of any product data, diagrams, charts, programs, algorithms, or circuit application examples contained in these materials.

All information contained in these materials, including product data, diagrams, charts, programs and algorithms represents information on products at the time of publication of these materials, and are subject to change by Suzhou Good-Ark Electronics Co., Ltd. without notice due to product improvements or other reasons. It is therefore recommended that customers contact Suzhou Good-Ark Electronics Co., Ltd. or an authorized Suzhou Good-Ark Electronics Co., Ltd. for the latest product information before purchasing a product listed herein. The information described here may contain technical inaccuracies or typographical errors. Suzhou Good-Ark Electronics Co., Ltd. assumes no responsibility for any damage, liability, or other loss rising from these inaccuracies or errors. Please also pay attention to information published by Suzhou Good-Ark Electronics Co., Ltd. by various means, including our website home page.

(<http://www.goodark.com>)

When using any or all of the information contained in these materials, including product data, diagrams, charts, programs, and algorithms, Please be sure to evaluate all information as a total system before making a final decision on the applicability of the information and products. Suzhou Good-Ark Electronics Co., Ltd. assumes no responsibility for any damage, liability or other loss resulting from the information contained herein.

The prior written approval of Suzhou Good-Ark Electronics Co., Ltd. is necessary to reprint or reproduce in whole or in part these materials.

Please contact Suzhou Good-Ark Electronics Co., Ltd. or an authorized distributor for further details on these materials or the products contained herein.